

422/VP-d1

422/VP-d2

422/VP-d3

LAMPENFASSUNG FÜR KOMPAKTSTOFFLAMPEN (TC-D, TC-T)
LAMP HOLDERS FOR COMPACT FLUORESCENT LAMPS (TC-D, TC-T)

Technische Daten

Technical data





- LAMPENSOCKEL - Lamp cap	G24d-1-2-3 GX24d-1-2-3
- Nennstrom und Nennspannung - Rated current and voltage	2A-250V
- Maximale Betriebstemperatur (IEC) - Maximum operating temperature (IEC)	T140
- Schutzgrad - Protection index	IP20
- Überspannungskategorie - Impulse withstand category	III

Merkmale

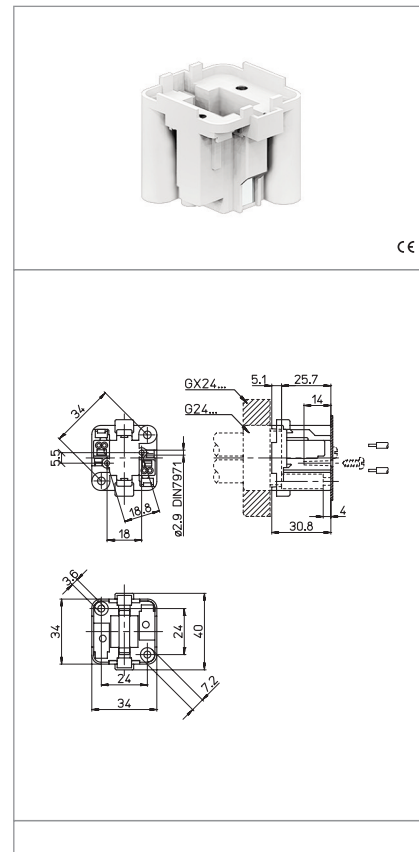
Characteristics

- Gehäuse aus PBT, weiss
- White PBT body
- Kupferlegierte Kontakte
- Copper alloy contacts



 Schraubbefestigung screw fixing	 Befestigung mit selbstschneidender Schraube fixing with self-tapping screw	 Steckkontakte mit 2 Löchern push-wire terminals with 2 holes	 Feste Leitungsabschnitte rigid conductor section 0,5-1 mm ²
 Leitungsabsolierung rigid wires stripping 8-9			

Prüfzeichen
Quality marks

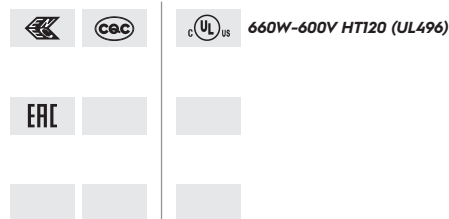

Europäische Richtlinien
European directives

gemäß "RoHS"
"RoHS" compliant
unterliegt nicht "WEEE"
Not subject to "WEEE"

Gewichte und Verpackung
Weights and packaging

Artikel/Art. Produktinweise Product references	g Nettogewicht Net weight	n° pz pro Beutel per bag	n° pz pro Box per box	n° pz pro Karton per carton
422/VP-d1	13,4	500	200	
422/VP-d2	13,3	500	200	
422/VP-d3	13,3	500	200	

Bemerkung

Notes